

2022

BANDELIN
Ultraschall seit 1955

High-power ultrasound for laboratory and process engineering



Cleaning – Dispersing – Homogenising
Cell disruption – Sample preparation

Content

Company portrait.....	2
SONOREX Ultrasonic baths.....	3–11
Application examples of SONOREX ultrasonic baths.....	3
SONOREX Ultrasonic baths – analogue or digital.....	4
SONOREX SUPER Ultrasonic baths with easy-to-operate turning knobs.....	5
SONOREX DIGITEC Ultrasonic baths with rapid degassing	6
SONOREX DIGIPLUS Ultrasonic baths with rapid degassing and power settings	7
SONOREX Accessories for cleaning	8
SONOREX Accessories – configuration examples.....	9
SONOREX Special accessories for process engineering	10
SONOREX Accessories	11
SONOREX Ultrasonic baths for special requirements.....	12–16
SONOREX DIGITEC DT...F Ultrasonic baths with flat oscillating tanks	12
SONOSHAKE Set Ultrasonic bath with shaking device for sample preparation	12
SONOREX Ultrasonic baths for cleaning of analysis sieves.....	13
SONOREX Ultrasonic bath PR 140 DH for volumetric glassware.....	14
SONOCOOL Ultrasonic bath with cooling for use in analytical laboratories and pathology	15
BACTOSONIC Special ultrasonic bath for gentle removing of biofilms	16
TICKOPUR and STAMMOPUR Cleaning and disinfecting agents	17–18
SONOPULS Ultrasonic homogenisers	19–27
SONOPULS Applications.....	20
SONOPULS Typical applications and choice of aspects	21
SONOPULS Construction and principle of operation	22
Ultrasonic homogenisers series HD 4000 – Features	23–24
SONOPULS Probes for series HD 4000.....	25–26
SONOPULS Probes for series HD 2000.2	27
SONOPULS Accessories	28–31
SONOPULS Standard and booster horns, flow-through horns and adapters	28
SONOPULS Processing vessels for direct sonication.....	29
SONOPULS Processing vessels for indirect sonication.....	30
SONOPULS Stand, foot switch, temperature sensors, sound proof boxes	31
FAQs	32–33
Our product range.....	34

BANDELIN Ultrasound since 1955

Company portrait

We are a family-owned company located in Berlin and meanwhile run in the third generation, specialised in development, manufacturing and sales of ultrasonic devices, the corresponding accessories and application-specific cleaning agents and disinfectants.

A wide vertical range of manufacture, modern production lines and a motivated staff guarantee a high quality of the products. Our devices contribute to the success of our customers in the laboratory, medical, dental, pharmaceutical, industrial, craft as well as service.

As early as 1955, our company began developing and manufacturing high-performance ultrasonic devices. The constant expansion of the product range and a sharp rise in sales led to an expansion of the production area in 1985. In 1992, ultrasonic homogenisers and controllable, power-constant ultrasonic generators were introduced to the market.

The period from 1996 to 2004 was characterised by the development and production of innovative ultrasonic baths and immersible transducers as well as tube reactors for industrial applications.

In the following years, BANDELIN's product range was expanded by new laboratory ultrasonic devices. After the introduction of the ultrasonic bath for simultaneous cleaning and rinsing of MIC instruments, a further development was launched in 2016 for robotic instruments.

Today, the reputation of our brands SONOREX, SONOPULS, SONOMIC and TRISON stand for the high quality awareness of our employees and is equated in expert circles with ultrasound.

The most important product groups include:

- SONOREX – Ultrasonic baths and reactors
- SONOPULS – Ultrasonic homogenisers
- SONOMIC – Ultrasonic baths for rinsable MIC and standard instruments
- TRISON – Ultrasonic baths for robotic-, rinsable MIS and standard instruments
- TICKOPUR – Cleaning agents
- STAMMOPUR – Cleaning agents and disinfectants

We are innovation leaders in the development of ultrasonic devices and new areas of application. In the past we have registered 79 patents / utility models as well as 68 trade brands. Our participation in various committees in the development of new standards and guidelines serve to ensure the highest standards for ultrasonic applications.

As the only complete supplier of ultrasonic devices, accessories, disinfectants and cleaning agents with approvals and certifications according to ISO 9001 and ISO 13485, BANDELIN is the market leader.

Over one million units have already been delivered to our customers.

Standard and customised solutions

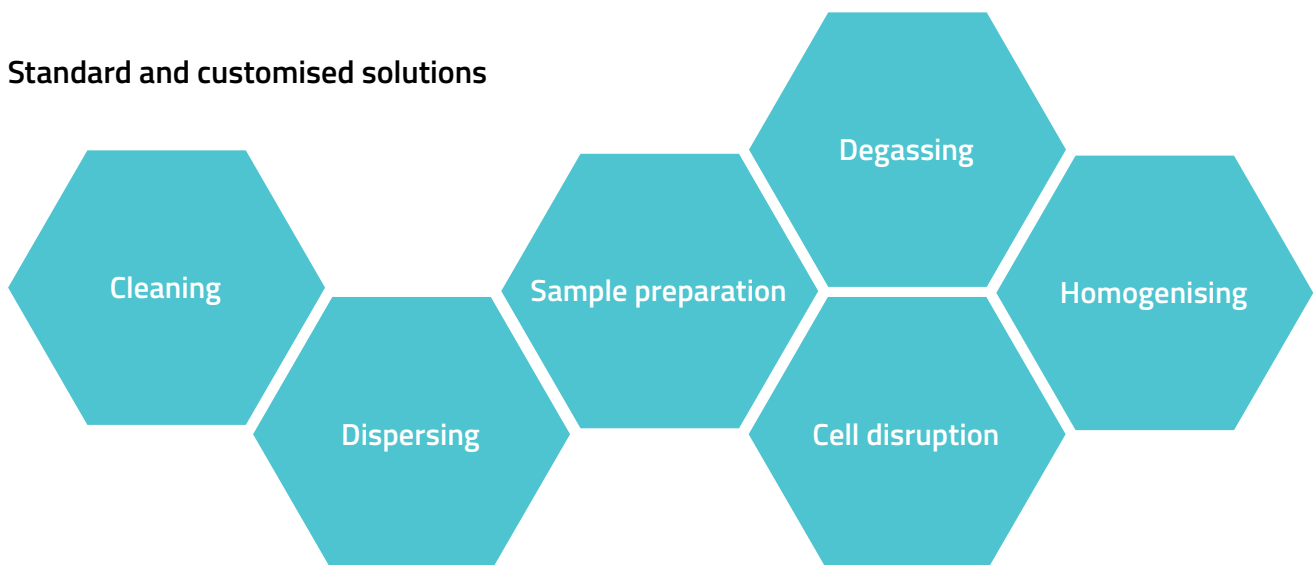

Application examples of **SONOREX** ultrasonic baths

Process engineering

- Degassing of beer samples for analysis of alcohol contents, original wort, colour, pH value
- Degassing of solvents for HPLC
- Degassing of food samples from cans for analysis of stannous content
- Test method for freeze-thaw resistance of concrete: CDF test – through sonication, loosely adhering scaled particles are removed from surface
- Extraction of quaternary ammonium compounds (QAC) of wood
- Extraction of herbs samples for determination of aflatoxines (causing mold decay on food)
- Extraction of soil samples for determination of hydrocarbons
- Production of emulsions, mixing of plasma and sera
- Homogenising of samples for residue analysis in vegetarian food
- Acceleration of chemical reactions
- Acceleration of suspending processes
- Preparation for pollutant analysis of either drinking or drain water
- Preparation of liposomes in cosmetics and pharmacy
- Preparation of samples for analysis of THC-content in cannabis
- Preparation of samples for analysis, e.g. analysis of hair



Cleaning

- Technical glassware like burettes, pipettes, petridishes etc.
- Analysis sieves
- Tableting punches
- Goggles, breathing masks
- All kinds of metal parts and electronic components
- Medical instruments
- Filters

Product information, safety data sheets and dosing tables are available:
www.bandelin.com/downloads ↓

Helpful application videos regarding cleaning, disinfection and degassing are available:
www.sonorex.info ▶

SONOREX

Ultrasonic baths – analogue or digital

More information about ultrasonic baths from page 5 to 8 you within the appropriate data sheet on our website:
www.bandelin.com/downloads ↓



	SUPER RK ...	DIGITEC DT ...	DIGIPLUS DL ...
Capacity [l]	0.9 – 90.0	0.9 – 90.0	3.0 – 28.0
Time setting [min]	1 – 15, ± 5 % continuous operation (∞)	1, 2, 3, 4, 5, 10, 15, 30, ± 5 % continuous operation (∞)	1, 2, 3, 4, 5, 10, 15, 30, ± 5 % continuous operation (∞)
Safety shut-down	–	after 12 hours	after 12 hours
Heating	optional, version „H“	optional, version „H“	3
Adjustable temperature range [°C]	30 – 80 RK 31 H: 65 fixed	20 – 80	20 – 80
Excess temperature signal	–	✓	✓
Protection against boiling retardation	–	✓	✓
Setting accuracy of bath temperature [K]	± 5 K	± 2.5 K	± 2.5 K
Thickness tank [mm] / material C-version:	0.8 / 1.4301 2.0 / 1.4404	0.8 / 1.4301 2.0 / 1.4404	0.8 / 1.4301 –
Filling mark for safe dosage	✓	✓	✓
Hard chromium-plated	RK 102 H	DT 102 H / H-RC	DL 102 H
One-piece drain, welded	✓, from RK 102 H	✓, from DT 102 H	✓
Degree of protection	IP 32	IP 33	IP 33
Ultrasonic frequency [kHz]	35	35	35
SweepTec	✓	✓	✓
Pulse function	✓	✓	✓
Power setting	–	–	20 – 100 % in 10 % steps
Oscillating systems	✓	✓	✓
Fast degassing DEGAS	–	✓	✓
Mains supply: 230 V~ (± 10 %) 50/60 Hz 115 V~ (± 10 %) 50/60 Hz	✓	✓	✓
Data memory	–	no, Type H-RC: WINSONIC® software	–
Interface / PC software	–	RS 232 bei Typ H-RC / 3	–
Medical device class I	✓	✓	–

SONOREX SUPER

Ultrasonic baths with easy-to-operate turning knobs

Advantages

- Fixed mains cable: prevents danger of short-cut
- Welded one-piece-outlet pipe for good tightness
- Turning knobs for slight transmission



Type	Internal tank dimensions l x w x d [mm]	Capacity [l]	Code No.	External dimensions l x w x h [mm]	Ultrasonic peak power* [W]	Ultrasonic nominal power [W]	Heating power [W]	Outlet ball valve
RK 31	190 × 85 × 60	0.9	329	205 × 100 × 180	160	40	–	–
RK 31 H			7523		160	40	70	–
RK 52	150 × 140 × 100	1.8	311	175 × 165 × 225	240	60	–	–
RK 52 H			164		240	60	140	–
RK 100	240 × 140 × 100	3.0	301	260 × 160 × 250	320	80	–	–
RK 100 H			312		320	80	140	–
RK 102 H			303		480	120	140	G ½
RK 103 H	240 × 140 × 150	4.0	326	260 × 160 × 310	560	140	200	G ½
RK 106	∅ 240 × 130	5.6	306	∅ 265 × 270	480	120	–	G ½
RK 156	500 × 140 × 100	6.0	305	530 × 165 × 245	640	160	–	G ½
RK 156 BH	500 × 140 × 150	9.0	646	530 × 165 × 300	860	215	600	G ½
RK 170 H	1000 × 200 × 200	39.0	7506	1050 × 250 × 385	1520	380	1600	G ½
RK 255	300 × 150 × 150	5.5	3066	325 × 175 × 295	640	160	–	G ½
RK 255 H			316		640	160	280	G ½
RK 510	300 × 240 × 150	9.7	327	350 × 265 × 300	640	160	–	G ½
RK 510 H			321		640	160	400	G ½
RK 512 H	300 × 240 × 200	13.0	795	325 × 265 × 350	860	215	400	G ½
RK 514	325 × 300 × 150	13.5	277	355 × 325 × 305	860	215	–	G ½
RK 514 H			207		860	215	600	G ½
RK 514 BH	325 × 300 × 200	18.7	263	355 × 325 × 385	860	215	600	G ½
RK 1028	500 × 300 × 200	28.0	322	535 × 325 × 400	1200	300	–	G ½
RK 1028 H			324		1200	300	1300	G ½
RK 1028 C	500 × 300 × 300	45.0	661	540 × 340 × 500	2000	500	–	G ½
RK 1028 CH	500 × 300 × 300	45.0	143	540 × 340 × 500	1200	300	1450	G ½
RK 1040	∅ 500 × 195	39.5	319	∅ 540 × 500	1520	380	–	G ½
RK 1050	600 × 500 × 200	58.0	323	640 × 540 × 425	2400	600	–	G ½
RK 1050 CH	600 × 500 × 300	90.0	184	640 × 540 × 530	2400	600	1950	G ½

*corresponds to 4 times ultrasonic nominal power

SONOREX DIGITEC

Ultrasonic baths with rapid degassing

Advantages

- Foil front panel for easy hygienic cleaning
- Fixed mains cable: prevents danger of short-cut
- Welded one-piece-outlet pipe for good tightness



Type	Internal tank dimensions l x w x d [mm]	Capacity [l]	Code No.	External dimensions l x w x h [mm]	Ultrasonic peak power* [W]	Ultrasonic nominal power [W]	Heating power [W]	Outlet ball valve
DT 31	190 x 85 x 60	0.9	3200	205 x 100 x 180	160	40	–	–
DT 31 H			3220		160	40	70	–
DT 52	150 x 140 x 100	1.8	3205	175 x 165 x 230	240	60	–	–
DT 52 H			3225		240	60	140	–
DT 100	240 x 140 x 100	3.0	3210	260 x 160 x 250	320	80	–	–
DT 100 H			3230		320	80	140	–
DT 102 H			3235		480	120	140	G ¼
DT 103 H	240 x 140 x 150	4.0	3201	260 x 160 x 310	560	140	200	G ¼
DT 106	∅ 240 x 130	5.6	3270	∅ 265 x 270	480	120	–	G ¼
DT 156	500 x 140 x 100	6.0	3275	530 x 165 x 245	640	160	–	G ¼
DT 156 BH	500 x 140 x 150	9.0	3221	530 x 165 x 300	860	215	600	G ¼
DT 255	300 x 150 x 150	5.5	3215	325 x 175 x 295	640	160	–	G ¼
DT 255 H			3240		640	160	280	G ¼
DT 510	300 x 240 x 150	9.7	3245	350 x 265 x 300	640	160	–	G ½
DT 510 H			3206		640	160	400	G ½
DT 512 H	300 x 240 x 200	13.0	3226	325 x 265 x 350	860	215	400	G ½
DT 514	325 x 300 x 150	13.5	3250	355 x 325 x 305	860	215	–	G ½
DT 514 H			3211		860	215	600	G ½
DT 514 BH	325 x 300 x 200	18.7	3216	355 x 325 x 385	860	215	600	G ½
DT 1028	500 x 300 x 200	28.0	3255	535 x 325 x 400	1200	300	–	G ½
DT 1028 H			3231		1200	300	1300	G ½
DT 1028 CH	500 x 300 x 300	45.0	3266	540 x 340 x 500	1200	300	1450	G ½
DT 1050 CH	600 x 500 x 300	90.0	3271	640 x 540 x 530	2400	600	1950	G ½

*corresponds to 4 times ultrasonic nominal power

DT ... RC baths with infrared interface for process documentation **

Type	Internal tank dimensions l x w x d [mm]	Capacity [l]	Code No.	External dimensions l x w x h [mm]	Ultrasonic peak power* [W]	Ultrasonic nominal power [W]	Heating power [W]	Outlet ball valve
DT 102 H-RC	240 x 140 x 100	3.0	3071	260 x 160 x 250	480	120	140	G ¼
DT 255 H-RC	300 x 150 x 150	5.5	3081	325 x 175 x 295	640	160	280	G ¼
DT 510 H-RC	300 x 240 x 150	9.7	3091	325 x 265 x 300	640	160	400	G ½
DT 514 BH-RC	325 x 300 x 200	18.7	3095	355 x 325 x 385	860	215	600	G ½

*corresponds to 4 times ultrasonic nominal power **WINSONIC DT remote control for MICROSOFT® WINDOWS®, required



WINSONIC DT remote control consisting of:
infrared adapter IR 1 and software CD

Code No. 3090

The PC program is designed for operating systems MICROSOFT® WINDOWS®2000 and MICROSOFT® WINDOWS® XP in connection with the infrared adapter IR 1 allowing a comfortable operation and monitoring of DIGITEC DT ... RC ultrasonic baths.

Interface for automation of laboratories

RS 232 data interface to the laboratory PC allows processing of individual control tasks and integration into an automated laboratory line.

SONOREX DIGIPLUS

Ultrasonic baths with rapid degassing and power settings

from 20 to 100 % in 10 % steps

Advantages

- Power reduction possible: recommended for cleaning of sensitive parts
- Foil front panel for easy hygienic cleaning
- Fixed mains cable: preventing danger of short-cut
- Welded one-piece-outlet pipe for good tightness











Type	Internal tank dimensions l x w x d [mm]	Capacity [l]	Code No.	External dimensions l x w x h [mm]	Ultrasonic peak power* [W]	Ultrasonic nominal power [W]	Heating power [W]	Outlet ball valve
DL 102 H	240 x 140 x 100	3.0	7180	260 x 160 x 250	480	120	140	G ¼
DL 156 BH	500 x 140 x 150	9.0	7181	530 x 165 x 300	860	215	600	G ¼
DL 255 H	300 x 150 x 150	5.5	7182	325 x 175 x 295	640	160	280	G ¼
DL 510 H	300 x 240 x 150	9.7	7183	325 x 265 x 300	640	160	400	G ½
DL 512 H	300 x 240 x 200	13.0	7184	325 x 265 x 350	860	215	400	G ½
DL 514 BH	325 x 300 x 200	18.7	7185	355 x 325 x 385	860	215	600	G ½
DL 1028 H	500 x 300 x 200	28.0	7186	535 x 325 x 400	1200	300	1300	G ½

*corresponds to 4 times ultrasonic nominal power

SONOREX

Accessories for cleaning

Picture (example)	Function
 <p>Insert basket K</p>	<p>Stainless steel, for placing the parts to be sonicated, when choosing the device, it is important to consider the dimensions of the basket.</p>
 <p>Insert baskets PK</p>	<p>With perforation in the bottom, for gentle cleaning of sensitive surfaces, polyethylene, for placing the parts to be sonicated, when choosing the device, it is important to consider the dimensions of the basket.</p>
 <p>Utensil holders GH</p>	<p>Stainless steel, for placing the parts to be sonicated, especially for laboratory flasks with larger diameters or large parts.</p>
 <p>Lid D</p>	<p>Stainless steel, condensation water runs back into the tank, slots for carrying the basket handles.</p>
 <p>Insert tubs KW</p>	<p>With lid. For working with chemicals that corrode the stainless steel oscillating tank. KW 3/5 made of polyethylene, other KW made of polypropylene, temperature resistant in water up to 80 °C and in acids up to 60 °C. Lid of KW 14, polycarbonate.</p>
 <p>Positioning lids DE</p>	<p>Stainless steel, for positioning inset beakers SD 06, PD 06, EB 05 or SD 09: DE 52 for 1 inset beaker DE 100 / 6 / 255 for 2 inset beakers DE 156 / 510 / 514 for 4 inset beakers. DE 08 for 2 inset beakers: SD 04, KB 04, SD 05</p>
 <p>Beaker holder ES 4</p>	<p>Stainless steel, for positioning 4 inset beakers: SD 06, PD 06, EB 05 or SD 09.</p>
 <p>Inset beakers EB / KB / PD / SD</p>	<p>Inset beakers for indirect cleaning of small parts, suitable for DE / ES</p> <p>EB 05, stainless steel, 600 ml SD 06, glass, 600 ml PD 06, polypropylene 600 ml</p> <p>} with ring GR 06 and lid DD 06 (made of polyethylene)</p> <p>SD 09, glass, 1000 ml with ring GR 06</p> <p>for DE 08:</p> <p>SD 04, glass, 400 ml SD 05, glass, 600 ml KB 04, polyethylene, 400 ml</p> <p>} with ring GR 04</p>
 <p>Inset sieve baskets KD 0 / PD 04</p>	<p>Inset sieve baskets</p> <p>KD 0 stainless steel, Ø inner diameter 75 mm, mesh net with mesh size 1×1 mm, suitable for inset beakers SD 06, PD 06, EB 05 or SD 09</p> <p>PD 04 polyethylene, Ø inner diameter 60 mm, bottom mesh net with mesh size 1×1 mm, suitable for PD 04, KB 04, SD 04, SD 05, SD 06, SD 09, EB 05, PD 06</p>

SONOREX

Accessories – configuration examples

Cleaning of parts placed into an insert basket directly in the ultrasonic tank

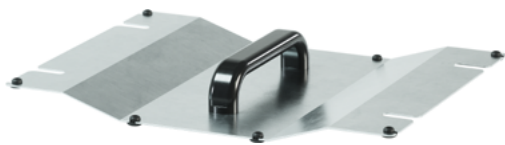

D 510

Indirect cleaning of parts in a plastic tub when using either solvents, acids or distilled water



EB 05

Indirect cleaning of small parts in inset beakers when using either solvents or acids



KD 0



PD 04



SD 06



PD 06



K 10



KW 10-0



DE 510



DL 510 H

Special accessories for process engineering



**Handle adjustment GV
for insert baskets and utensil holders**

Stainless steel,
stepless adjustment of immersion depth, no overflow of laboratory flasks.
Quick and easy to attach.

GV 3: 2 pieces, suitable for baskets K 1 C, K 3 C/CL, K 5 C, K 6 BL
GV 10: 2 pieces, suitable for baskets K 10/B, K 14/B, K 28/C,
and in utensil holders GH 10, GH 14 and GH 28



Spring clamps EK for laboratory flasks

Stainless steel,
neither floating nor canting of flasks. Quick and easy fixing to the bottom of insert baskets or utensil holders, with mesh sizes up to 12.5 × 12.5 mm.

EK 10 for 10-ml-laboratory flask to dia. 31 mm max., dia. 23 mm min.
EK 25 for 25-ml-laboratory flask to dia. 42 mm max., dia. 30 mm min.
EK 50 for 50-ml-laboratory flask to dia. 52 mm max., dia. 35 mm min.
EK 100 for 100-ml-laboratory flask to dia. 65 mm max., dia. 40 mm min.
EK 250 for 250-ml-laboratory flask to dia. 85 mm max., dia. 55 mm min.

Suitable for baskets K 3 C/CL, K 5 C, K 6, K 10/B, K 14/B, K 28/C, for utensil holder GH 10,
GH 14 and GH 28, flask holder GL 510 F and shaking device SA 1028



Holders for laboratory flasks ZF

Stainless steel,
fixing of laboratory flasks in insert baskets,
precise fitting without any effort and additional tools,
available as set, three different lengths, longitudinal and cross dividers,
simple mounting by means of small hooks at the rim of the basket,
individual compartmentation possible,
additional suggestion: handle adjustment GV 10 for insert baskets

ZF 28 for basket K 28 / K 28 C – 9 holders for laboratory flasks à 215 mm and
4 holders for laboratory flasks à 420 mm

ZF 10 for basket K 10 / K 10 B – 5 holders for laboratory flasks à 155 mm and
3 holders for laboratory flasks à 215 mm

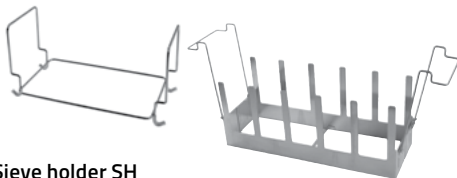

Sieve holder SH

Stainless steel,
SH 7: single cleaning of sieves up to dia. 200 mm, for RK / DT 106
SH 28 C: cleaning from 1 to 5 analysis sieves up to dia. 200 mm for RK 1028 C

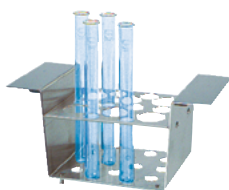

Test tube holder RG 2

Stainless steel,
for simultaneous sonication of up to 6 test tubes up to dia. 25 mm and up to
8 test tubes up to dia. 16 mm. Also useable as a stand for draining the test tubes.
Content always visible.
Suitable for ultrasonic baths RK/DT 52/H, RK/DT 100/H, RK/DT 102 H/H-RC,
RK/DT 103 H, DL 102 H

SONOREX Accessories

	Lid	Insert basket stainless steel l x w x d [mm]	Insert basket polyethylene l x w x d [mm]	Utensil holder ground area l x w [mm]	Insert tube l x w x d [mm]	Positioning lid be- aker holder
RK 31 / H DT 31 / H	D 08	K 08 170 x 65 x 50	–	–	–	DE 08
RK 52 / H DT 52 / H	D 52	K 1 C 120 x 110 x 40	–	GH 1 129 x 117	–	DE 52
RK 100 / H RK 102 H DT 100 / H DT 102 H / H-RC DL 102 H	D 100	K 3 C 200 x 110 x 40	PK 2 C 187 x 90 x 56	GH 1 129 x 117	KW 3 195 x 115 x 88	DE 100
RK 103 H DT 103 H	D 100	K 3 CL 200 x 110 x 40	–	GH 1 129 x 117	KW 3 195 x 115 x 88	DE 100
RK 106 DT 106	D 6	K 6 dia. 215 x 50	–	–	–	DE 6
RK 156 DT 156	D 156	K 6 L 460 x 100 x 50	–	–	–	DE 156
RK 156 BH DT 156 BH DL 156 BH	D 156	K 6 BL 460 x 100 x 50	–	–	–	DE 156
RK 170 H	D 170	K 7 950 x 150 x 50	–	–	–	–
RK/DT 255 / H DT 255 H-RC DL 255 H	D 255	K 5 C 260 x 110 x 40	–	–	KW 5 254 x 96 x 130	DE 255
RK/DT 510 / H DT 510 H-RC DL 510 H	D 510	K 10 250 x 195 x 50	–	GH 10 260 x 200	KW 10-0 242 x 182 x 136	DE 510
RK 512 H DT 512 H DL 512 H	D 510	K 10 B 250 x 195 x 50	–	–	–	DE 510
RK 514 / H DT 514 / H	D 514	K 14 275 x 245 x 50	–	GH 14 280 x 250	KW 14 280 x 215 x 145	DE 514
RK / DT 514 BH DT 514 BH-RC DL 514 BH	D 514	K 14 B 275 x 245 x 50	–	–	KW 14 B 275 x 210 x 195	DE 514
RK 1028 / H DT 1028 / H DL 1028 H	D 1028	K 28 455 x 245 x 50	–	GH 28 455 x 250	KW 28-0 437 x 230 x 155	ES 4
RK 1028 C RK 1028 CH DT 1028 CH	D 1028 C	K 28 C 455 x 245 x 50	–	–	KW 28-0 437 x 230 x 155	ES 4
RK 1040	D 40	K 40 dia. 480 x 50	–	GH 28 455 x 250	–	–
RK 1050	D 1050 C	K 50 545 x 450 x 50	–	–	KW 50-0 517 x 445 x 184	ES 4
RK 1050 CH DT 1050 CH	D 1050 C	K 50 C 545 x 450 x 50	–	–	KW 50 B-0 520 x 445 x 284	ES 4

More detailed information you can find in the data sheets of the ultrasonic baths on www.bandelin.com 

SONOREX DIGITEC DT... F

Ultrasonic baths

with flat oscillating tanks



consisting of: SONOREX DIGITEC DT 510 F, 1 flask holder GL 510 F, 250 ml TICKOPUR R 33
SONOREX DIGITEC DT 1028 F, 2 flask holders GL 510 F, 250 ml TICKOPUR R 33

- Uniform sonication of samples irrespective of size and arrangement of the flasks
- Reproducible results
- Homogenising or rapid degassing of samples
- Spring clamps EK 10 – 250 prevent floating or tilting of laboratory flasks (see page 12)

Type	Internal tank dimensions l x w x d [mm]	Capacity [l]	Code no.	External dimensions l x w x h [mm]	Ultrasonic peak power* [W]	Ultrasonic nominal power [W]	Outlet ball valve	Accessories	Suitable for GL 510 F	Code no.
DT 510 F	300 x 240 x 65	4.3	3242	325 x 265 x 195	560	140	G ½	GL 510 F EK 10 EK 25 EK 50	18 x 18 x 9 x	3262 7521 7519 7518
DT 1028 F	500 x 300 x 65	9.5	3243	535 x 325 x 205	1280	320	G ½	EK100 EK 250	6 x 5 x	7516 3259

*corresponds to 4 times nominal power

SONOSHAKE Set

Ultrasonic bath with shaking device for sample preparation

SONOSHAKE offers a wide range of applications for sample preparation in many areas of analysis, for example, in environmental and foodstuffs analytics as well as in the area of medical diagnostics. Sedimentation in the sample can be solved by defined shaking. An additional sonication allows a good homogenising.

- Analogue settings of time and shaking frequency
- Reciprocating motion: settings in 4 steps possible
- Constant amplitude of 20 mm independently of loading
- Rack easy to remove
- Fast mounting of laboratory clamps EK 10 –250 (separately to order)
- Shaking platform approx. 410 x 280 mm [l x w]
- Mounting of approx.
36 x 10-ml-flasks or 36 x 25-ml-flasks or
18 x 50-ml-flasks or 12 x 100-ml-flasks or
10 x 250-ml-flasks
- Required floor space approx. 850 x 360 mm [l x w]

The shaking device SA 1028 can be added to existing ultrasonic bath DT 1028 F.

SONOSHAKE set Code No. 3257
SA 1028 Code No. 3249



Further information you will find here
www.sonoshake.info

SONOREX

Ultrasonic baths for the cleaning of analysis sieves

Analysis sieves are test equipment with very high accuracy which are especially used in the fields of quality control in research and production. A thorough cleaning of analysis sieves is the basis for precise and reproducible results. Therefore, manufacturer of sieves recommend a cleaning of sieves by ultrasound. By cleaning in an ultrasonic bath, the particles are removed also from finest meshes (< 500 µm), contamination of the next sample will be prevented. There is no changing of mesh size and material tension.

Not only analysis sieves can be cleaned effectively and thoroughly, but also a mill tools.

Analysed sieves which are used in sieve shakers are cleaned intensively and gentle within a few minutes. The sieves are ready for the next analysis within a very short time.

We recommend our universal cleaning concentrate. TICKOPUR R 33 (page 19) as well as a suitable sieve holder SH (page 11).

Further information watch application video:
www.sieves.bandelin.com 

For cleaning of a single sieve:

Type	Internal tank dimensions l x w x d [mm]	Capacity [l]	Code no.	for analysis sieves up to dia. [mm]	Ultrasonic peak power* [W]	Ultrasonic nominal power [W]	Accessories [mm]	Code no.
DT 106	dia. 240, 130	5.6	3270	200	480	120	SH 7	314
RK 106	dia. 240, 130	5.6	326	200	480	120	SH 7	314
RK 1040	dia. 500, 195	39.5	319	500	1520	380	GH 28	290

For simultaneous cleaning of up to five sieves:

RK 1028 C	500 x 300 x 300	45.0	661	200	2000	500	SH 28 C	307
-----------	-----------------	------	-----	-----	------	-----	---------	-----

*corresponds to 4-times nominal power



RK 1028 C
with SH 28 C



DT 106 with SH 7

SONOREX PR 140 DH

Ultrasonic bath for the cleaning of volumetric glassware with lengths up to 755 mm

Clean and particularly fatty-free glass surfaces are necessary for a correct volume measurement: The liquid to be measured must flow well down the glass wall and must not form droplets.

Ready-to-operate set:

- Ultrasonic bath pipettes washer PR 140 DH
- Inset basket K 140 B
- Lid D 140 D
- Cleaning concentrates
TICKOPUR R 33 – 5 liters
TICKOPUR TR 3 – 1 liter

Code No. 2070



PR 140 DH with K 140 B and D 140 D

Features

- For reusable volumetric glassware as well as long parts up to 755 mm length
- Heating for better removing of fatty residues
- Frequency modulation "Sweep" for a very homogeneous ultrasonic field; damages at the glass surface are nearly prevented, attacking of graduation as well as glass corrosion will be avoided compared to manual cleaning with rough sponges or brushes
- Placing onto the floor near the drain is possible
- Simultaneous cleaning and disinfection with STAMMOPUR 24 in case of infectious contamination
- Biologically degradable agent TICKOPUR for gentle removing of stubborn fatty residues (R 33) or mineral ones (TR 3)
- Multiple use of cleaning solution is possible
- Ultrasonic tank made of stainless steel AISI 304 (1.5 mm thickness)
- Handles for easy transport within the lab
- Operation foil keypad guarantees a simple cleaning of the housing surface
- All functions like time, DEGAS or optionally temperature can be set at the push of the button
- Drain with ball valve for easy and fast emptying

Further information you will find here
www.pr140.gb.bandelin.com 

SONOCOOL

Ultrasonic bath with cooling for use in analytical laboratories and pathology

The SONOCOOL ultrasonic bath is intended for use in laboratories and facilities for industrial and scientific research as well as material testing institutes. With the bath it is possible to use the catalytic effect of ultrasound for processes during which simultaneous cooling is required. Heat-sensitive samples are protected by the cooling function and process sequences can be designed to be faster and more effective than customary procedures.

Advantages of the SONOCOOL SC 255.2

- Compact and powerful – ultrasound and cooling in one device
- Air-cooled cooling unit
- Dissipation of the process heat caused by the ultrasound
- Adjustable bath temperature: 4 to 40 °C at 20 °C room temperature
- Individual parameter variation (time, temperature, performance) and thus adaptation to the respective test specimen
- Long lifespan – welded tank 1.4404, material thickness 2 mm
- Monitoring of the fill level
- Glass lid: Sample observation, easy cleaning

Applications in a laboratory

(constant temperature conditions required)

- Sample preparation for subsequent analysis, e.g. determination of chemical and biological agents (especially chromium [VI] analytically)
- Dissolve solids in solvents and degas eluents

Advantage: Temperature-sensitive materials are not destroyed/attacked

Ready-to-use laboratory set:

- Ultrasonic bath SC 255.2
- Insert basket K 5 C
- Lid D 255 G
- Contact liquid TICKOPUR TR 3 – 250 ml (concentrate)

Code No. 3500032 – 230 V EU plug CEE 7/7
3500032-GB – 230 V GB plug BS 1363
3500032-CH – 230 V CH plug T 12 type J



SC 255.2, insert basket K 5 SC and sample holder PH 255-11

For more information, visit

www.sonocool.info ↓

Applications in pathology

- Acceleration of decalcification of femoral head preparations, shin stem preparations and osteosarcomas
- Acceleration of decalcification of hard tooth tissue for histopathological processing

Advantages: Significant reduction of decalcification times without negatively affecting the quality of the specimen and improvement of the cutting quality

Ready-to-use pathology set:

- Ultrasonic bath SC 255.2
- Sample holder PH 255-11
- Lid D 255 G
- Insert beaker SD 01.2 – 20 pcs.
- Contact liquid TICKOPUR TR 3 – 250 ml (concentrate)

Code No. 3500031 – 230 V EU plug CEE 7/7
3500031-GB – 230 V GB plug BS 1363
3500031-CH – 230 V CH plug T 12 type J

BACTOSONIC

Ultrasonic special bath for gentle removing of biofilms

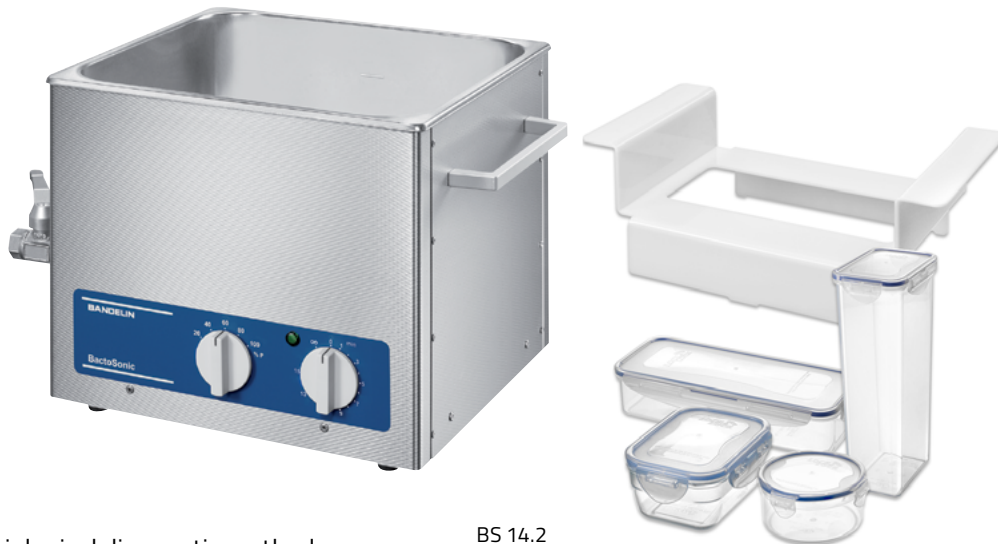

BS 14.2

Fast microbiological diagnostic method for implant-associated infections

The successful treatment of implant infections depends on an accurate microbiological diagnosis. Microorganisms form biofilms on implant surfaces, what makes them difficult to detect by conventional methods. BactoSonic gently removes biofilms from implant surfaces.

Principle of BactoSonic

The implants are placed in the airtight implant boxes and sonicated in the specially designed ultrasonic bath BactoSonic.

Compared to other ultrasonic baths, BactoSonic works with a **very low ultrasonic intensity and increased homogeneity**. The biofilm is removed without killing the bacteria, a quantitative assessment is possible.

The sonicated liquid is cultured and the quantity of bacteria can be determined. Compared to standard methods (e.g. biopsies from periprosthetic tissue) up to 10,000 times more bacteria can be detected.

Mixed infections and different bacteria morphotypes can better be identified.

The sensitivity especially of patients with previous antibiotic therapy is improved.

BactoSonic 14.2, consisting of:

- Ultrasonic bath BS 14.2
- Wire frame for foil test
- Scientifically tested procedure
- Concentrat for producing contact liquid TICKOPUR R 33 – 250 ml
- Implant boxes (polypropylene)
 - 2 pcs. IB 5 0.52 l
 - 2 pcs. IB 6 0.6 l
 - 1 pc. IB 10 1.0 l
 - 1 pc. IB 18 1.8 l
 - 1 pc. IB 20 2.0 l
- Box trays BT 5, BT 6, BT 10, BT 18 (polycarbonate)
GH 14 (stainless steel)

Code No. 3291



Further information you will find here www.bactosonic.de

TICKOPUR and STAMMOPUR

Cleaning and disinfecting agents



Dosing aids

	usable for	Code No.
Pump ①	5-l-jerrycan	268
Pump ①	10-l-jerrycan	2660
Measuring beaker ②	100 ml	294



Besides ultrasonic power, temperature and time, specially balanced cleaning and disinfectant agents are also necessary to achieve optimum cleaning results. BANDELIN offers a wide range of adequate cleaning agents from DR. H. STAMM GmbH. These cleaning agents were specially developed for ultrasonic applications. With their cavitation-aiding properties, the special agents support the process and are gentle to the material at the same time. Depending on the cleaning tasks, either alkaline, neutral or acidic cleaning agents are recommended. They are biologically degradable and easy to dispose of. Rinsing after cleaning is necessary to remove remaining residues of cleaning agents and diluted soil particles from the parts to be cleaned.

It is not allowed to use combustible liquids directly in the ultrasonic bath. Household cleaners, acids and most of the customary acid cleaners are improper cleaning agents because they could attack the tank by pitting corrosion resulting finally in breakdown of the ultrasonic bath.

All TICKOPUR agents are also suitable for immersing and wiping.

Product information, safety data sheets (SDS) and dosing table: www.bandelin.com/downloads ↓

Demulsifying cleaning agents:

Fat and oil float to the surface and is therefore easy to be skimmed.

Emulsifying cleaning agents:

Fat and oil removed from the surface of the parts is bound by the cleaner and held in suspension. When removing the cleaned parts from the bath liquid no recontamination takes place.

Contamination	Objects to be cleaned	Concentrate	Litres
General contamination, oily and greasy residues, soot, ink, drilling, grinding, polishing and lapping residues etc.	Glass, ceramics, plastics, rubber, steel, stainless steel, non-ferrous-, precious- and light metals, sieves, pipettes, respirators, PC-boards, glasses. Caution with tin and zinc.	TICKOPUR R 33 Universal cleaner gentle cleaning, anticorrosive Mildly alkaline, pH 9.9 (1 %) Dosage 3 to 5 %, 1 to 10 min EXAM-expertise	1 2 5 10 200
Light drilling, grinding, polishing and lapping residues, dust, soot, oily and greasy residues etc.	Glass, ceramics, plastics, rubber, steel, stainless steel, non-ferrous-, precious- and light metals	TICKOPUR R 30 Neutral cleaner gentle cleaning, anticorrosive Neutral, pH 7 Dosage 1 to 5 %, 1 to 10 min emulsifying	1 2 5 10
Heavy mineral residues like limescale, silicate, phosphate, rust, cement, temper colours, metal oxides, grease and oil films etc.	Glass, ceramics, plastics, rubber, steel, stainless steel, precious metals. Not for light and non-ferrous metals, tin and zinc!	TICKOPUR R 27 Special cleaner – based on phosphoric acid Acidic, pH 1.9 (1 %) Dosage 5 %, 1 to 10 min emulsifying	1 2 5 10
Resinous residues, soot, grease, oils, waxes, pigments, coloured fog, silicon oils, flux media, oxides at copper, brass, bronze and precious metals.	Glass, ceramics, plastics, rubber, steel, stainless steel, non-ferrous- and precious metals, analysis sieves. Caution with light metals.	TICKOPUR RW 77 Special cleaner with ammonia without phosphate, gentle to material Mildly alkaline, pH 9.9 (1 %) Dosage 5 %, 1 to 10 min emulsifying	1 2 5 10
Coke residues, resinous residues, soot, pigments, grease, oils, waxes, silicon oils, coloured fog, drilling, grinding, polishing and lapping residues etc.	Glass, ceramics, plastics, rubber, steel, stainless steel. Not for light metals, tin and zinc!	TICKOPUR R 60 Intensive cleaner saponifying, without phosphate Alkaline, pH 12.8 (1 %) Dosage 2 to 20 %, 1 to 10 min emulsifying	1 2 5 10
Mineral residues, drifting rust, grease, oils, waxes, pigments, drilling, grinding, polishing and lapping residues.	Steel, stainless steel, non-ferrous, precious and light metals, glass, ceramics, plastics, rubber.	TICKOPUR TR 3 Special cleaner – based on citric acid gentle cleaning, without phosphate, anticorrosive Weakly acidic, pH 3.0 (1 %) Dosage 5 %, 1 to 10 min emulsifying	1 2 5 10 200
Coke residues, resinous residues, soot, grease, oils, waxes, pigments, coloured fog, drilling, grinding, polishing and lapping residues.	Steel, stainless steel, glass, ceramics, plastics, rubber Not for tin, zinc and light metals! Non-ferrous metals can be affected.	TICKOPUR TR 13 Intensive cleaner – demulsifying for stubborn contamination, without phosphate and silicate Alkaline, pH 11.9 (1 %) Dosage 0.1 to 10 %, 1 to 10 min emulsifying	1 2 5 10 200
General contamination, biofilms, soot, pigments, oil- and fat-containing residues etc.	Glass, ceramics, plastics, rubber, steel, stainless steel, non-ferrous-, precious- and light metals, instruments, pipettes, respirators, protective goggles etc.	STAMMOPUR 24 Intensive instrument cleaning and disinfection Residue-free rinsing, neutral scent. Very gentle to material. Free from aldehydes, chlorine and phenols. Bactericidal, yeasticidal, virucidal against Vaccinia, BVDV, H5N1, HBV, HCV, HIV. Mildly alkaline, pH 9.9 (1 %) Application with ultrasound: 1 % – 15 min, 2 % – 5 min VAH certified, EXAM-expertise	2 5 10

■ Detailed advice and technical documentation: Phone +49 30 76880-258

SONOPULS

Ultrasonic homogenisers

SONOPULS Ultrasonic homogenisers are mainly used for homogenising, desagglomerating, emulsifying, suspending, acceleration of chemical reactions as well as for disruption of cells, bacteria, fungi or spores. Significantly reduced processing times and quickly available results make the ultrasonic homogenisers indispensable for modern processes and in analysis. Using ultrasonic homogenisers certain substances can

be selectively destroyed, tedious preparation processes can be shortened and results of many reactions are improved. When sonicating samples not only μm particles can be achieved but also particles in nm range!

With many years of experience in the field of ultrasonic homogenisers we assist you in your specific application.



1964

Manufacture of the first ultrasonic homogeniser with tube generator
SONOREX HE 1



2020

SONOPULS series 4000
ultrasonic homogenisers

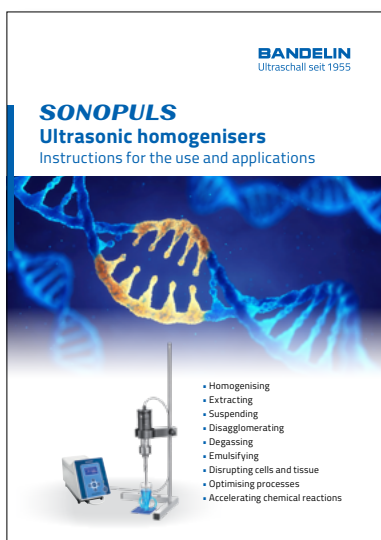

Our application guide can be requested:
info@bandelin.com ✉

Take a look at our application video:
www.sonopuls.info ▶

SONOPULS

Applications

Typical areas of application

- Disruption of cells without destroying the cell content
- Disruption of tissue, also mixed tissue
- Emulsifying of hardly mixable liquids, e.g. oil and water, particle size in nm range
- Deagglomeration of nanoparticles in material research (nanostructured material) in medicine, biotechnology, automobile industry
- Acceleration of chemical reactions
- Dispersing

Analysis

- Preparing samples for grain size determination or environmental analysis
- Homogenising of cheese samples for determination of nitrates

Biochemistry – Biology – Medicine

- Sonication of small high-quality samples for analysis like EIA or RIA
- Due to high amplitudes, disruption of either high-resistant bacteria, cells or tissues is possible. Indirect processing of samples in cup booster BR 30 or in cup horn BB 6 are recommended to avoid crosscontamination
- Detection of prions by cyclic amplification of protein misfolding

Chemistry – Sonochemistry

- Acceleration of chemical reactions or destroying of highly-molecular compounds

Pharmacy – Cosmetics

- Production of larger volumes of long lasting emulsions, e.g. lotions and production of antigens, vaccines or liposomes

General information (extract)

- 5119 General information on ultrasonic homogenisers
- 5169 Power determination
- 5159 Life span of probes
- 5972 Application guide

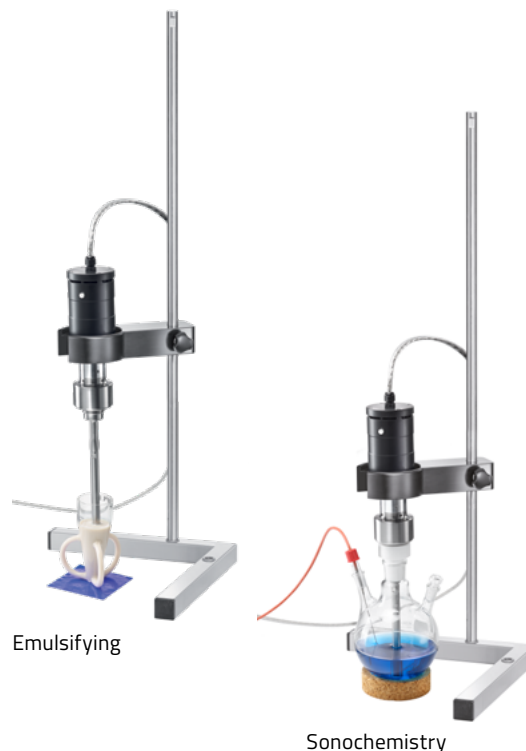

Professional hints (extract)

Molecular Biology – Microbiology – Pharmacy – Medicine

- B-101 Protein extraction by indirect sonication
- B-102 Disruption of yeasts cells
- B-103 Procurement of stroma-free haemolysate / paternity test
- B-106 Tissue disruption, especially „difficult“ tissues – overview
- B-108T Escherichia coli
- B-109 Disruption of pseudomonas thailandensis
- B-111 Protein isolation for Westernblot
- B-207 Cell disruption of micro algae and cyano bacteria
- B-209 Producing of lysates of eucaryotic cells

Materials

- C-104 Dispersing of carbon nanotubes (CNT) in processing oil
- C-203 Sample preparation of ceramic suspensions for measuring the particle size
- C-209 Phase transfer of ferric oxides nanoparticles

Environment

- C-106 Desagglomeration of water and sediment samples
- C-110 Preparation of sewage samples
- C-201 Extraction of magnesium out of soils
- C-210 Sample preparation of sewage water for determining of TOC according to DIN EN 1484

SONOPULS

Typical applications

Producing an oil / water emulsion

Small production of pharmaceutical formulations, e.g. very fine emulsions like lotions

> no agglomerates, no sedimentation

Volume: 500 ml

Our recommendation:

HD 2200.2 with KE 76

HD 4200 with TS 106



Homogenising of brain

Volume: 50 ml

Our recommendation:

HD 2070.2 with MS 73

HD 4100 with TS 103

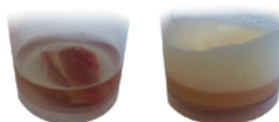

Homogenising of Pangasius fish

Volume: 20 g in 90 ml water

Our recommendation:

HD 2200.2 with VS 70 T

HD 4200 with TS 113



Homogenising of cheese for subsequent determining of nitrate

Volume: 10 g cheese in 25 ml water

Our recommendation:

HD 2200.2 with KE 76

HD 4200 with TS 106



Essential aspects for choosing the appropriate ultrasonic homogeniser

What is the difference between ultrasonic homogenisers and ultrasonic baths?

The power [W] of ultrasonic baths is fixed. The power density [W/l] is relatively low.

Ultrasonic homogenisers have an adjustable power [W] and produce very high power densities [W/l].

Probes with a defined radiating surface guarantee reproducible results.

What is more important when choosing the appropriate device – power rating or amplitude?

Power output [W] is not the sole criterion for selecting the ultrasonic homogeniser. This value only indicates the power of the ultrasonic generator but not the energy delivered into the sample. The amplitude at the radiating surface of the probe is the determining factor while considering the sample volume. SONOPULS homogenisers provide higher amplitudes than comparable devices in the market due to an optimal matching of all components.

Which information are necessary for an offer?

Application field

e.g.: homogenising, dispersing, extraction, cell disruption

Target of sonication

e.g.: isolation of cell content

Volume

batch operation of flow-through operation (quantity per time unit)

Viscosity

in [mPas]

Solids content

suspensions in [%]

Temperature range

e.g.: temperature sensitive, cooling necessary

Components

e.g.: alcoholic or acidic

SONOPULS

Construction and principle of operating

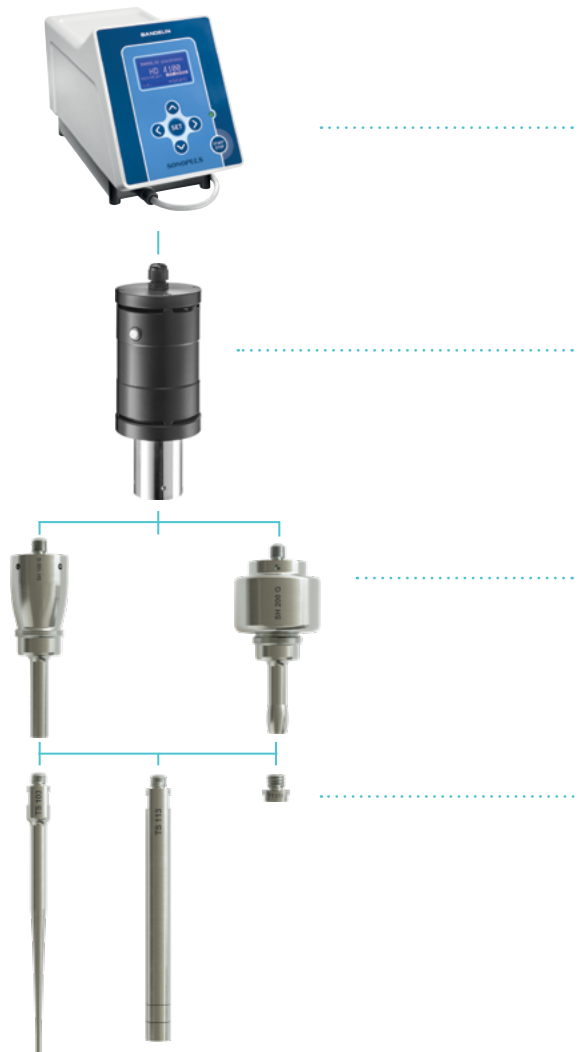

Ultrasonic generator (control unit)

Transforming of low-frequency voltage of 50 or 60 Hz into high frequency voltage of 20 kHz. Controlling and displaying of process parameters and sequences.

Ultrasonic converter

Transforming electrical voltage delivered from the generator into mechanical vibrations of 20 kHz

Standard and booster horns

titanium alloy TiAl6V4 (3.7165)

Increasing amplitudes delivered from the ultrasonic converter. The amplification depends on the their shape.

Probes

titanium alloy TiAl6V4 (3.7165)

Transmitting the mechanical vibrations into the sample. The radiating surface is located on the tip of the probe, but not on the sides. The higher the amplitude the more intense the sonication and the more erosion at the radiating surface of the tip. Due to their shapes probes multiply the amplitudes. This is followed by highest power densities in the sample.

Features

The AMPLICHRON-system guarantees a constant amplitude and thus reproducible results independently from changing conditions within the sample. Settings within a range of 10 to 100 % are possible. Verification of actual value at the display. Permanent control of ultrasound irradiation as well as indication of wear of the probe.

Pulsation

Limits temperature increase when processing heat-sensitive samples. The adjustable pulsation allows cooling during rest intervals.

Continuous operation

Constant sound radiation – extremely effective

Integrated timer

Duration of sonication storable; indication of elapsed time during continuous operation or of remaining time in countdown mode.

Switching ON / OFF – easy to handle

Either at the generator or directly at the ultrasonic converter via button or foot switch.

Foil keypad – easy-care and user-friendly.

Fail-safe during continuous operation and idling.

SONOPULS-homogenisers and their special accessories are „In vitro diagnostic medical devices class 5“ (according to 98/79/EG).

SONOPULS

Ultrasonic homogenisers series HD 4000 – Features



Sample volumes - Batch - Flow-through	0.5 to 1000 ml up to 30 l/h
Ultrasonic converter	possible configurations: GM 4200 with UW 50 or UW 100 or UW 200 or GM 4400 with UW 400 or UW 200
Amplitude setting	10 to 100 %
Automatic amplitude limiting	after input of the assembled probe
Pulsation	ON cycles 0.2 – 600 s OFF cycles 0.3 – 600 s
Time setting	0:00:01 – 9:59:59 [h:mm:ss] or continuous operation
Safety shut-down	9 h: 59 min: 59 s
Indicators	alphanumerical LC display of amplitude, pulse level, time, energy input and temperature (optional)
Energy display	in kJ
Temperature display and measurement	optional, -10 to 120 °C, temperature sensor required, alternatively beep or switch off
Batch operation Sequencing	✓ several batches one after the other
Remote control with PC	RS 232 (Sub-D)
Fault diagnosis	✓
Operating frequency	20 kHz
Program memory	✓, 9
Functional test	✓
Mains connection	230 V~ (±10 %), 50/60 Hz

ADVANCED

SONOPULS HD 4050

for volumes from 0.5 to 100 ml



Ready-to-use set:

for volumes from 0.5 to 20 ml
ultrasonic nominal power max. 50 W

- Ultrasonic generator GM 4200
- Ultrasonic converter UW 50
- Probe TS 102, dia. 2 mm

Code No. 4050

SONOPULS HD 4200

for volumes from 5 to 1000 ml



Ready-to-use set:

for volumes from 20 to 900 ml
ultrasonic nominal power max. 200 W

- Ultrasonic generator GM 4200
- Ultrasonic converter UW 200
- Booster horn SH 200 G
- Titanium flat tip TT 213, dia. 13 mm

Code No. 4200

SONOPULS HD 4100

for volumes from 2 to 200 ml



Ready-to-use set:

for volumes from 3 to 50 ml
ultrasonic nominal power max. 100 W

- Ultrasonic generator GM 4200
- Ultrasonic converter UW 100
- Standard horn SH 100 G
- Probe TS 103, dia. 3 mm

Code No. 4100

SONOPULS HD 4400

for volumes from 100 to 3000 ml



Ready-to-use set:

for volumes from 500 to 2000 ml
ultrasonic nominal power max. 400 W

- Ultrasonic generator GM 4400
- Ultrasonic converter UW 400
- Booster horn SH 400 G
- Probe TS 425, dia. 25 mm

Code No. 4400

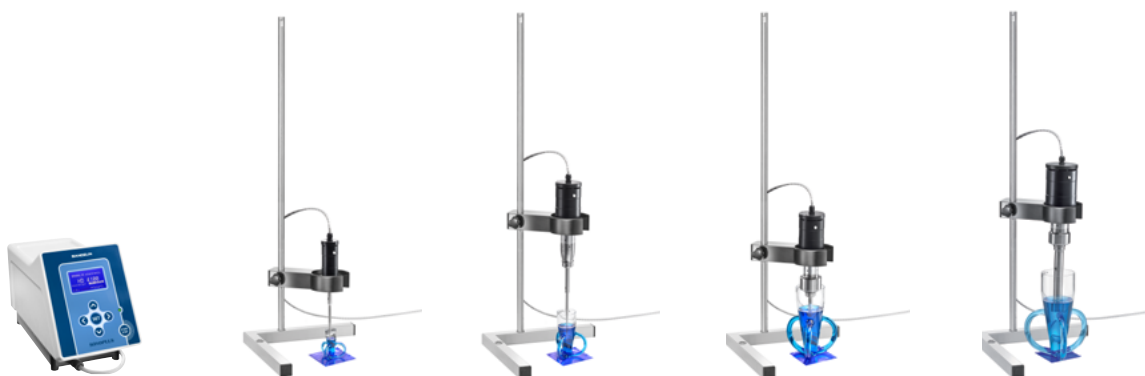

	HD 4050	HD 4100	HD 4200	HD 4400
Ultrasonic generator	GM 4200	GM 4200	GM 4200	GM 4400
l × w × h [mm]	150 × 220 × 335	150 × 220 × 335	150 × 220 × 335	150 × 220 × 335
Ultrasonic converter	UW 50	UW 100	UW 200	UW 400
Dia. × l [mm]	45 × 175	70 × 150	70 × 150	86 × 180
Available probes dia. [mm]	2/3/4,5/6/9	2/3/4,5/6/9/13	3/4,5/6/9/13/16/19/25	13/16/19/25/32/38

SONOPULS

Probes for series HD 4000



Type	TS 102	TS 103	TS 104	TS 106	TS 109	TT 213	TS 113	TS 216	TS 219	TS 225
Code No.	3740	3741	3742	3743	3744	3750	3745	3746	3747	3748
Diameter [mm]	2	3	4,5	6	9	13	13	16	19	25
Length* approx. [mm]	157	147	133	128	126	–	130	137	145	153
Standard horn for HD 4100	SH 100 G	SH 100 G	SH 100 G	SH 100 G	SH 100 G	SH 100 G	SH 100 G	–	–	–
Booster horn for HD 4200	–	SH 200 G	SH 200 G	SH 200 G	SH 200 G	SH 200 G	SH 200 G	SH 200 G	SH 200 G	SH 200 G
Amplitude HD 4050/4100/4200 (peak to peak) [µm]	125/260/–	118/245/280	90/195/235	70/155/210	58/130/185	–/80/128	–/82/132	–/–/90	–/–/68	–/–/50
Volume HD4050 [ml]	0,5–20	1–25	3–50	5–75	10–100	–	–	–	–	–
Volume HD 4100 [ml]	2–25	3–50	5–75	10–100	15–150	20–200	20–200	–	–	–
Volume HD 4200 [ml]	–	5–90	5–100	10–350	10–500	20–900	20–900	25–900	25–900	30–1000



Type	TS 413	TS 416	TS 419	TS 425	TS 425 L	TS 432	TS 438
Code No.	3752	3753	3754	3755	3759	3756	3757
Diameter [mm]	13	16	19	25	25	32	38
Length* ca. [mm]	139	132	129	130	254	136	144
Booster horn for HD 4400 [mm]	SH 400 G	SH 400 G	SH 400 G	SH 400 G	SH 400 G	SH 400 G	SH 400 G
Amplitude HD 4400 (peak to peak) [µm]	242	196	142	82	82	59	42
Volume HD 4400 [ml]	100–750	250–1000	250–1500	500–2000	500–3000	500–2500	500–3000

* Probes are tuned to their working frequency. Lengths may vary slightly due to variations in the titanium alloy.

Probe extensions

They are used for enlarging the length of the probe to operate in deep vessels and are mounted between standard or booster horn and probe/titanium flat tip. TS 113 V between SH 100 G/SH 200 G and probe TS 113 or titanium flat tip TT 213.

Type	TS 113 V
for HD	4100/4200
Code No.	3666



SONOPULS

Probes for series HD 2000.2



Type	MS 72	MS 73	KE 76	TT 13	VS 70 T	VS 190 T	TT 25	VS 200 T
Code No.	492	529	530	497	494	3638	532	478
Diameter [mm]	2	3	6	13	13	19	25	25
Length* approx. [mm]	195	179	137	5	130	130	6	130
Standard horn for HD 2070.2	SH 70 G	SH 70 G	SH 70 G	SH 70 G	SH 70 G	–	–	–
Booster horn for HD 2200.2	SH 213 G	SH 213 G	SH 213 G	SH 213 G	SH 213 G	SH 219 G	SH 225 G	SH 225 G
Amplitude HD 2070.2 (peak to peak) [µm]	285	245	191	93	97	–	–	–
Amplitude HD 2200.2 (peak to peak) [µm]	286	308	255	165	170	81	53	51
Volume HD 2070.2 [ml]	1–25	2–50	5–100	10–200	10–200	–	–	–
Volume HD 2200.2 [ml]	2–30	5–90	10–350	20–900	20–900	25–900	30–1000	30–1000

* Probes are tuned to their working frequency. Lengths may vary slightly due to variations in the titanium alloy.



Probe extensions

They are used for enlarging the length of the probe to operate in deep vessels and are mounted between standard or booster horn and titanium flat tip.

VS 70 between SH 70 G / 213 G and TT 13

VS 200 between SH 225 G and TT 25

Type	VS 70	VS 200
for HD	2070.2 / 2200.2	2200.2
Code No.	500	415

SONOPULS

Accessories

Standard and booster horns SH and TH

They amplify and transmit the vibrations to the probe. The suitable horn will be tightened to the ultrasonic converter.

Horns SH for adapting replaceable probes; horns TH have a fix peak. With external thread for connection of different vessels by the use of a sleeve adapter.



	for replaceable probes						with fix peak			
	Standard horns		Booster horns				Standard horn	Booster horns		
Type	SH 70 G	SH 100 G	SH 213 G	SH 219 G	SH 225 G	SH 200 G	SH 400 G	TH 100 G	TH 200 G	TH 400 G
for UW	2070	100	2200			200	400	100	200	400
Code No.	486	3731	527	3647	3634	3732	3734	3968	3969	3970

Flow-through horns FZ

They are used to produce stable mixtures of non mixable or hardly mixable liquids (oil / water). Different vessels with standard ground can be connected via adapters NA to the external thread of the horn. In combination with two different media flow-through cell DG 4 G can be sonicated directly in the cavitation field. A cooling is also possible.



	Flow-through standard horn	Flow-through booster horn
Type	FZ 5 G	FZ 7 G
for UW	2070 / 100	2200 / 200
Code No.	490	452
Accessories	Titanium flat tip TT 13 FZ, Code No. 496	

Sleeve adapters

made of PTFE are for tight mounting of standard ground glass vessels to standard or booster horns with external threads.



Type	NA 29 G	NA 45 G
for	<ul style="list-style-type: none"> NS 29 / 32 SH 70 G / 100 G / SH 200 G / 213 G TH 100 G / 200 G FZ 5 G / FZ 7 G with probe diameters max. 13 mm 	<ul style="list-style-type: none"> NS 45 / 40 SH 70 G / 100 G / 200 G / SH 213 G / 219 G / SH 225 G / 400 G TH 100 G / 200 G / 400 G FZ 5 G / FZ 7 G with probe diameters max. 25 mm
Code No.	540	487

Flange adapter FA

made of stainless steel, for mounting standard or booster horns with external threads to processing vessels or pipe systems.



Type	FA 3 G
for UW	2070(2200/100/200/400)
Code No.	474

Processing vessels made of glass for direct sonication

Rosette cells RZ

Caused by the sound pressure the sample will be pushed against the vessel bottom and can circulate well through the side arms. When placing the rosette cell into crushed ice, the sample will be effectively cooled because of an enlarged glass surface and improved circulation.

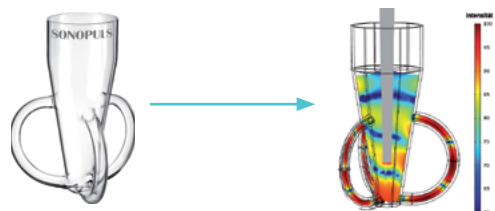

RZ 3

Intensity of distribution
(Distance between probe tip and vessel bottom = 3 cm)
Reference: Beuth Hochschule Berlin

Cooling vessels KG

They are used for processing temperature-sensitive samples. Their cooling jackets allow a circulation of the cooling liquid during the sonication.

Flow-through vessels DG

They are equipped with cooling jackets. A continuous sonication of sample up to 30 l/h is possible in flow-through. The cooling jackets allow a circulation of the cooling liquid during the sonication.



KG 3

DG 3

Type	Rosette cells					Cooling vessels		Flow-through vessels		
	RZ 1	RZ 2	RZ 3	RZ 4	RZ 5	KG 3	KG 5	DG 3	DG 5	DG 6
for probe dia. [mm]	2 – 3	2 – 6	3 – 13	13 – 25	19 – 25	2 – 13	13 – 25	2 – 13	13 – 25	25 – 38
max. volume [ml]	25	50	100	410	660	20	90	–	–	–
max. flow-through rate [l/h]	–	–	–	–	–	–	–	5.6	30	30
Internal dia. [mm]	27	40	50	75	90	20	35	20	35	71
Depth [mm]	80	95	130	200	240	55	95	55	100	120
Cooling jacket	–	–	–	–	–	✓	✓	✓	✓	✓
Sleeve adapters	–	–	–	–	–	–	–	–	–	–
Code No.	3606	3607	522	3256	483	536	481	538	482	3819

Flow-through processing vessels made of stainless steel for direct sonication

They will both directly mounted to the external thread of the standard or booster horn. They are especially used for emulsifying, mixing and homogenising. The liquid will be pumped from below against the radiating surface of the probe, passes directly the cavitation field and leaves the processing chamber via the outlet. A multiple circulation is possible. The sonication level depends on the set amplitude and the flow-through rate.



Type	DG 4 G	DZ 300 E*
for HD	2070.2 / 2200.2 4100 / 4200	4400
max. flow-through rate [l/h]	50	130
max. pressure [bar]	2	4
Cooling jacket	✓	–
Code No.	3608	3822

*not suitable for use with TS 438

Processing vessels for indirect sonication

An indirect sonication prevents the direct contact between probe and sample. These processing vessels can be compared with very small high-intense ultrasonic baths. The ultrasound is transmitted via the contact liquid into the sample vessels. The intrusion of titanium particles of the probe is excluded. An indirect sonication is especially recommended when processing smallest sample quantities: Foaming or sample lost do not take place. This method is suggested for treating pathogenic samples – crosscontamination is excluded.

To use cup horn BB 6 or cup booster BR 30 horn an probe must be replaced. Reaction vessels containing the samples are placed together with the suitable holder EH into BB 6 or BR 30. They are sonicated from below. The cavitation is produced in the contact liquid and transferred into the samples.

Microtube holder EH 3.1

For simultaneous sonication of up to 8 samples.

Three changeable discs for:

3 × 1 ml or 2 ml reaction cups

3 × 0.5 ml reaction cups

8 × 0.2 ml PCR cups

Microtube holder EH 6

For simultaneous sonication of up to 6 samples.



Type	BB 6	EH 6	BR 30	EH 3.1
for	HD 2200.2 4200	BB 6	HD 2070.2 / 2200.2 4100 / 4200	BR 30
Code No.	3605	7503	7510	7527



Configuration example of a LS 40 and HG 40
(WH 40 are a necessary accessories for an indirect sonication)

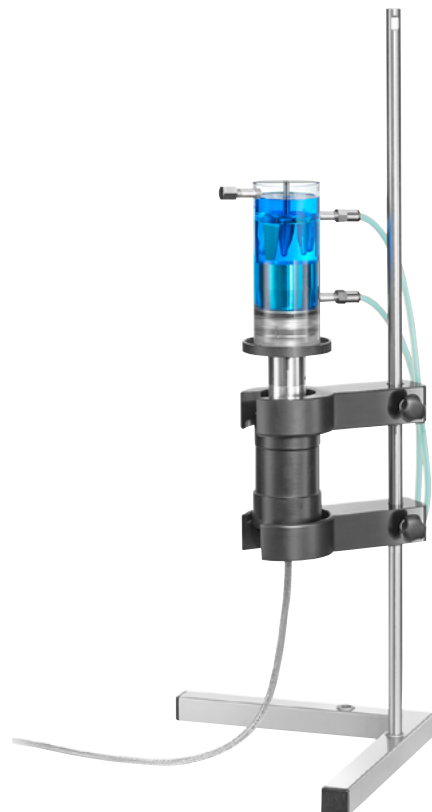

Configuration example UW 200 with BB 6, EH 6 and HG 40 with WH 40

Stand HG, holder WH, support AT

HG 40 includes one holder WH 40 for fixing the ultrasonic converter to the rod of the stand.

A second holder WH 40 is necessary either for indirect processing with BB6 / TR 110 / BR 30 or as a holder for the support table AT 40. WH 40 in combination with AT 40 enable an easy positioning of the sample vessel.

Type	HG 40	WH 40	AT 40
for HD	2070.2 / 2200.2 3100 / 3200 / 3400 4050 / 4100 / 4200 / 4400		
Code No.	3681	3900	3901



Sound proof boxes LS

Cavitation produces unpleasant noises for the user and other people nearby. We recommend the use of sound proof boxes to reduce the noise level.

Features LS 4:

- Noise reducing by approx. 10 dB-AU
- Openings at the rear side for hoses and temperatur sensor
- Full-sized plexiglass door enables process observation; with locking hinges at 0° and 150°



LS 4

LS 40

Foot switch TS

It is applicable for hand-free switching ON/OFF of the device. Delivered with 3 m connecting cable.

Type	TS 8
for HD	2070.2 / 2200.2 3100 / 3200 / 3400 4050 / 4100 / 4200 / 4400
Code No.	513



Temperature sensors TM

When connecting the temperature sensor to the ultrasonic generator the temperature module is activated. Temperatures in a range from 0 to 100 °C can be measured.

Type	TM 50	TM 100
for HD	3100 / 3200 / 3400 / 4050 / 4100 / 4200 / 4400	
Code No.	3733	3622

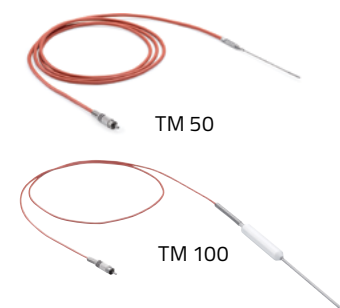

TM 50

TM 100

Features LS 40:

- Noise reducing by approx. 30 dB-AU
- LED interior lighting and acrylic glass for process viewing
- removeable drip tray made of stainless steel, easy cleaning
- Stainless steel insert easy to clean
- Closeable bushing at the rear side to accomodate lines and hoses for cooling or circulation systems or to connect a temperature sensor
- Ventilating system for reducing a process-related formation of moisture
- Door opening angle 180° for easy sample handling
- Sufficient space for either direct or indirect application by using stand HG 40 and other optional accessories

Type	LS 4	LS 40
for HD	2070.2 / 2200.2 3100 / 3200 4050 / 4100 / 4200	2070.2 / 2200.2 / 4050 / 4100 / 4200 / 4400
Damping in dB-AU	10	30
Code No.	416	3682

FAQs

What is the meaning of ultrasound?

Vibrations at frequencies exceeding 18 kHz (18.000 vibrations per second) are called ultrasound. As a result of these vibrations millions of smallest vacuum bubbles are formed in liquids. They implode during the high pressure phase and create highly effective pressure waves. This process is called cavitation. Lower frequencies of approx. 20 kHz which are applicable in cell disruption, produce bubbles with larger diameters and stronger pressure waves than higher frequencies of approx. 35 kHz which are used for intense but gentle cleaning. All ultrasonic baths use SweepTec. A very homogeneous and even ultrasonic field is achieved. The pulse function guarantees a steady high ultrasonic peak power.

Advantages of ultrasonic cleaning

Ultrasonic cavitation removes dirt rapidly from items, thoroughly and deep from pores, even from difficult to reach places such as cavities or holes. Ultrasound cleans only in a few minutes and exceeds in its efficiency other cleaning methods. Ultrasonic cleaning is also gentle because even slight damage like scratches are eliminated.

Advantages in process engineering and sonochemistry

Cavitation not only can be used for various purposes, but a very fine emulsion of oil and water can be produced by ultrasonic application. Compared to other manufacturing processes this emulsion is more stable. For sonochemical processes in an ultrasonic bath, the reaction vessel should have a thin bottom. Thus, the ultrasonic energy is radiated directly and effectively into the reaction vessel.

How do I select the proper device?

SONOREX ultrasonic baths work with the cleaning intense ultrasonic frequency of 35 kHz. Size and number of objects to be cleaned determine size of the bath. When selecting the unit, dimensions of the accessories, e.g. baskets have to be considered. To avoid overloading, it is recommended to choose a slightly larger unit. This also allows additional applications at a later stage.

Should an ultrasonic unit have a heating?

Warm cleaning solutions reduce the cleaning time; dirt is removed faster. With heaters are the preferred choice for cleaning processes in laboratories.

Disinfectant solutions must not be warmed-up because protein coagulation starts at a temperature of 40 °C (104 °F) and this poses an obstacle for some cleaning and all disinfection processes. Therefore, units without heaters are recommended for the use in the medical field.

Is it necessary to use either a basket or a holder for positioning the parts to be processed?

In case of direct contact between parts to be sonicated tank bottom an excessive wear is possible (increased cavitation erosion). When using either a basket or a holder the tank bottom will be protected and damages on sonicated objects will be avoided. A free space of approx. 2 to 3 cm is necessary for creation of cavitation.

Is the use of a lid necessary during sonication?

Yes, while using a lid the sound level will be reduced and the tank liquid will be protected from outside dirt. Condensed water runs back into the ultrasonic tank because of the lid design.

Which cleaning agents are appropriate?

TICKOPUR and STAMMOPUR cleaning and disinfectant agents have been especially developed for application in ultrasonic baths. Water without any cleaning agent does not clean. Household detergents as well as distilled water should never be used. It is necessary to use plastic inset tubs, when working with acids or removing acid residues. Flammable liquids must not be used directly in the ultrasonic tank.

When should the cleaning solution be changed?

It depends on the level and kind of contamination and on the quantity of parts already cleaned. In case of too much contaminated liquid there is a noticeable decrease in ultrasonic cleaning action and the liquid has to be replaced. The user always assumes the responsibility.

What does SWEEP mean?

SWEEP is a special frequency modulation (Sweep) around an optimally fixed operation point in order to prevent load-dependent vibrations.

Very rapid frequency changes of approx. ± 1 kHz after each 10 ms reduce standing waves in the bath. It is followed by an improved cleaning effect.

Very homogeneous ultrasonic field to avoid damages at sensitive parts.

How can I check the function of an ultrasonic bath?

We recommend the foil test according to IEC/TR 60886. An aluminium foil will be stretched over a wire frame and sonicated for approx. 3 minutes. A foil perforation has to be visible.

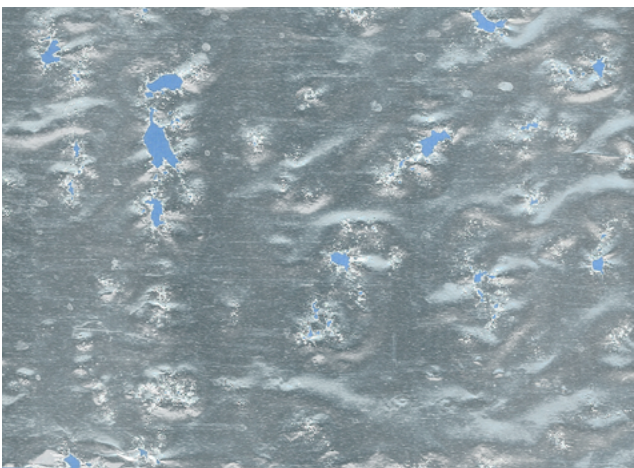

Take a look at our application video:

www.foiltest.info 

How do I determine the power density of an ultrasonic bath?

$$\text{Power density [W/l]} = \frac{\text{Ultrasonic nominal power [W]}}{\text{Filling volume [l]}}$$

What does it mean:

- Ultrasonic power – 100 Watt effective or ultrasonic nominal power?
- 2 x 200 Watt continuous HF peak output?
- 400 Watt ultrasonic peak power?

Nearly all baths in the market work in a so called double half-wave operation. All three mentioned values base on the same effective power!

Can the set temperature be kept constant?

Ultrasonic baths with heater are equipped with a temperature setting. If the set temperature is reached, the heater switches off, but the temperature in the bath will be increased by ultrasound: The mechanical energy of the ultrasound is transferred into heating energy. If a constant temperature of about 20 °C is demanded, an external cooling system absorbing at least the ultrasonic energy is required. The use of a cooling tube connected to a water cycle is not sufficient.

Is a degassing of the liquid necessary before starting the process?

Yes, for a few minutes to expel dissolved gas bubbles as these bubbles will affect the cleaning effectiveness. The duration depends on the bath size and the water hardness. You will notice a change in sound when degassing is completed – the ultrasonic bath works more silent.

How many parts can I place in my ultrasonic bath in one step?

The more parts you place into the ultrasonic bath the less efficiently it will clean. Parts should not overlap. Plenty of clear space between the parts has to be realised. Bulk good is not allowed.

Can ultrasound damage the parts to be sonicated?

Thousands of implosions (of cavitation bubbles) per second take place which are very powerful. However, ultrasonic cleaning is a very safe process as the cavitation is localised at a microscopic level. The cavitation bubble have a diameter of 1 to 3 nm, only! Please be carefully when choosing the liquid. It is far more likely that the liquid could damage the parts than the ultrasonic action.

Can I put my hands into the tank liquid while the bath is working?

To be sure that the sonication process is completed, the parts / samples should not be removed until selected time. Hands must not be put into liquid during the sonication process as it could cause damage to joint tissues and thus could result in longterm arthritic conditions.

Is a hearing protection necessary?

Yes, during long-term operation within distances of 2 m.

Our product range

With a unique and wide range of equipment and accessories, we supply ultrasonic baths, ultrasonic homogenisers as well as disinfection and cleaning agents for each ultrasonic application – **all from one hand!**



Further information regarding SONOREX ultrasonic baths from 0.5 to 200 l for laboratory, industry, medicine, dentistry or service you can find in the specific brochures:

www.bandelin.com/downloads/prospekte ↓

SONOREX TECHNIK ultrasonic baths, immersible transducers, reactors and ultrasonic generators and for industrial application. Customised assemblies.



SONOMIC and **TRISON** ultrasonic baths for the pre-cleaning of MIS and robotic instruments.



SONOPULS ultrasonic homogenisers from 20 to 400 W for cell disruption, dispersing or sonochemistry in laboratory and pilot plant scale.

SONOREX special ultrasonic baths for laboratory.

Made in Germany

BANDELIN electronic
GmbH & Co. KG
Heinrichstraße 3 – 4
12207 Berlin
DEUTSCHLAND
☎ +49 30 76880-0
☎ +49 30 7734699
info@bandelin.com

Certified in accordance with
ISO 9001 and ISO 13485



Tell us your requirements –
We will be pleased to advise you at no obligation.

+49 30 76880-18
www.bandelin.com

51012-002 en/2022-02
Subject to technical alterations without notice.
Dimensions subject to production tolerances.
Illustrations exemplary, not true to scale.
Decoration products are not included in delivery.
The General Business Terms and Conditions apply.